

Article number: 231111302

Description: E+G Visual flow indicators HVF.66-SST-1/4

Measures

HVF. (66 - 92)
HVF-SST (66 - 92)

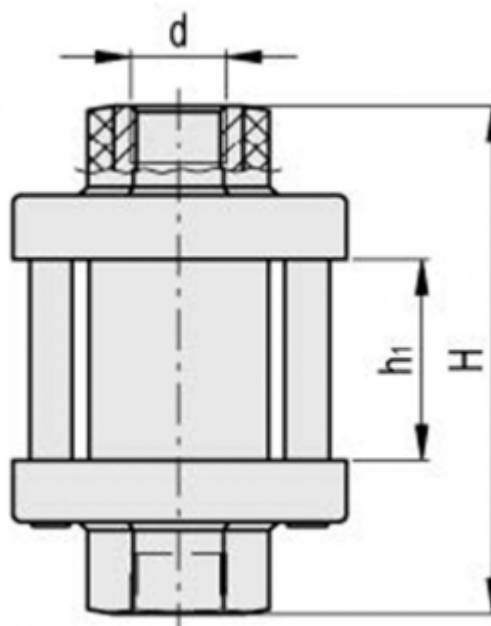
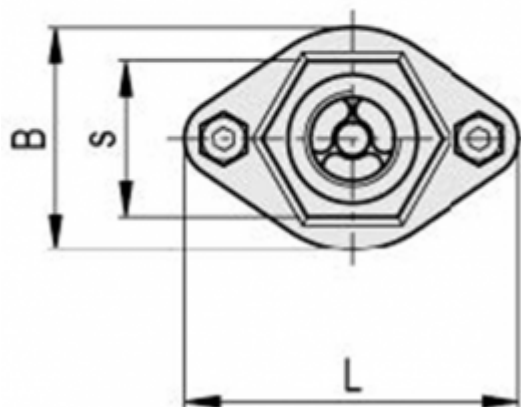

B	= 27
d	= 1/4
H	= 66
h1	= 22
L	= 44
s	= 20
Weight in (g)	= 74